

HIGH PERFORMANCE SPRAY GUN MAS PRO-88



Important

Declaration of Conformity available on request

This manual contains **IMPORTANT, WARNINGS** and **INSTRUCTIONS**.

Equipment in this manual is exclusively for painting purpose.

Do not use for other purpose.

The operator shall be fully conversant with the requirements stated in this instruction manual including important warnings, cautions and operation and correct handling.

Read and understand the instruction manual, before use and retain for reference.

Be sure to observe warnings and cautions in this instruction manual.

If not, it can cause paint ejection and serious bodily injury by drawing organic solvent.

Be sure to observe following marked items which are especially important.

WARNING	Indicates a potentially hazardous situation which, if not avoided, may result in serious injury or loss of life.
CAUTION	Indicates a potentially hazardous situation which, if not avoided, may result in minor or moderate injury or property damage.
Important	Indicates notes which we ask you to observe. The safety precautions in this instruction manual are the minimum necessary conditions. Following national and local regulations regarding fire prevention, electricity and safety as well as your own company regulations.

Main Specifications

Model	Type of feed	Atomization technology	Nozzle range mm	Pattern width (@1.3mm) mm/inch	Air consumption lpm/cfm	*Rec. working pressure bar/psi	Max. Pressure bar/psi	Max. Temp. °C	Mass g/lbs
MAS PRO-88-HV	Gravity	HVLP	φ1.0~2.8	280/11	400/14	2.0/29	6.8/98	5~40	450/1.0
MAS PRO-88-MP	Gravity	MP(LVMP)	φ1.0~2.8	300/11.8	270/9.5	2.0~2.5/29~36	6.8/98	5~40	450/1.0

*Means air pressure at gun inlet when trigger is pulled and air flows.

Safety precautions

WARNING

Fire and explosion

- Spark and open flames are strictly prohibited.**
Paints can be highly flammable and can cause fire.
- Never use the following HALOGENATED HYDROCARBON SOLVENTS**
Which can cause cracks or dissolution on gun body (aluminum) by chemical reaction.
*unsuitable solvents: methyl chloride, dichloromethane, 1,2-dichloromethane, carbon tetrachloride, trichloroethylene, 1,1,1-trichloroethane
(Be sure that all fluids and solvents are compatible with gun parts)
- Securely ground spray gun by using air hose with built-in ground wire.**
Ground wire: Less than 1MΩ. Check the earth stability periodically.
If not, insufficient grounding can cause fire and explosion due to static electric sparking.



Improper use of equipment

- Never point gun toward people or animal.**
If done, it can cause inflammation of eyes and skin or bodily injury.
- Never exceed maximum operating pressure and maximum operating Temperature**
- Be sure to release air and fluid pressures before cleaning, disassembling or servicing**
If not, remaining pressure can cause bodily injury due to improper operation or scattering cleaning liquid.
In order to release pressure, first stop supply of compressed air, fluid and thinner to spray gun.
Then remove needle adjust knob and pull fluid needle set toward you.
- Tip of fluid needle set has a sharp point.**
Do not touch the tip of fluid needle during maintenance for the protection of human body.



Protection of human body

1. **Use in a well-ventilated site by using spray both.**
If not, poor ventilation can cause organic solvent poisoning and catch fire.
2. **Always wear protective gear (safety glasses, mask, gloves)**
If not, cleaning liquid, etc., can cause inflammation of eyes and skin.
If you feel something wrong with eyes or skin, immediately see a doctor.
3. **Wear earplugs if necessary.**
Noise level can exceed 85dB(A), depending on operating conditions and painting site.
4. **If operators pull the trigger many times during operation, it may cause carpal tunnel syndrome.**
Be sure to take a rest if you feel tired.



Other precautions

1. **Never alter this spray gun.**
If done, it can cause insufficient performance and failure.
2. **Enter working areas of other equipment (robots, reciprocator, etc.) after machines are turned off.**
If not, contact with them can cause injury.
3. **Never spray foods or chemicals through this gun.**
If done, it can cause accident by corrosion of fluid passages or adversely affect health by mixed foreign matter.
4. **If something goes wrong, immediately stop operation and find the cause.**
Do not use again until you have solved the problem.

How to connect

CAUTION

- **Use clean air filtered through air dryer and air filter.**
If not, dirty air can cause painting failure.
- **When you use this gun for the first time after purchasing, adjust fluid needle packing set.**
Due to this gun's unique no rubber o-ring design, it is normal that the needle packing may be a little bit overtight or loose after a period of not using it.
To fix it, please just slowly tighten fluid packing seat and loosen a bit when fluid needle set does not return smoothly, and adjust so that fluid needle set smoothly moves.
- **If you use this gun for the first time after purchasing, to remove rust preventive oil inside, it is suggested to manually clean the fluid passages by spraying thinner and carefully clean air cap, nozzle and needle with brush and thinner.**
If not, remaining preventive oil can cause painting failure such as fish eyes.
Washing machine may not be able to get the gun cleaned completely.
- **Firmly fix hose or container to spray gun.**
If not, disconnection of hose and drop of container can cause bodily injury.
- **Use an air hose with minimum 9mm inner diameter.**
Depending on hose length, larger I.D. hose may be required.

1. Connect an air hose to air nipple tightly.
2. Connect a fluid hose or a container to fluid nipple tightly.
3. Flush the gun fluid passage with a compatible solvent.
4. Insert the filter into the fluid inlet of gunbody. Make sure the body of the filter is pushed fully so the body of the filter does not protrude from the cup insert.
5. Attach the Gravity Cup to the fluid inlet, pour paint into container, test spray and adjust fluid output as well as pattern width.
If the finish is too dry, reduce airflow by reducing air inlet pressure. If finish is too wet, reduce fluid flow by turning fluid adjusting knob clockwise.
If atomization is too coarse, increase inlet air pressure. If too fine, reduce inlet pressure.

How to operate

1. The recommended air inlet pressure is 2.0bar/29psi for HVLP and 2.0-2.5bar/29-36psi for LVMP (MP). Do not use more pressure than is necessary to atomise the material being applied. Excess pressure will create additional overspray and reduce transfer efficiency.
2. Recommended paint viscosity differs according to paint property and painting conditions, 18±2 sec./ DIN4 cup is recommendable.
3. Keep fluid output as small as possible to the extent that the job will not be hindered. It will lead to better finishing with the atomization.
4. Set the spray distance from the gun to the work piece within the range of 150-200mm (6-8in).
5. The gun should be held so that it is perpendicular to the surface of the work piece at all times. Then, the gun should move in a straight and horizontal line. Arcing or tilting may result in uneven coating.

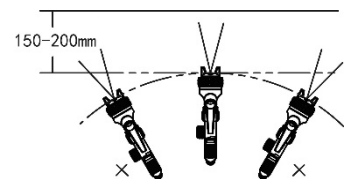

Maintenance and inspection

WARNING

- First release air and pressure fully according to item No.2 of “Improper use of equipment” of WARNING on page 1 to 2.
- Tip of fluid needle set has a sharp point. Do not touch the tip of needle valve at the maintenance.
- Be careful not to damage the tip of fluid nozzle.
- Only an experienced person who is fully conversant with the equipment can do maintenance and inspection.

CAUTION

- Never use commercial or other parts instead of original spare parts.
- Never immerse the whole gun into any solvent or cleaning solution such as thinner for over 1 minute.
If not, it may be detrimental to the lubricants, and the seals inside may be out of shape and lead to leakage, even there's no any rubber parts used inside the gun, such as o-ring.
- When replacing the fluid nozzle or fluid needle, replace both at the same time.
Using worn parts can cause fluid leakage. Also, replace the needle packing at this time.
Torque the fluid nozzle to 18~20Nm (160~180lb.in).
- To prevent damage to fluid nozzle or fluid needle, be sure to either pull the trigger and hold while tightening or loosening the fluid nozzle, or remove fluid adjusting knob to relieve spring pressure against needle collar.
- The gravity cup is made from special anti-static materials, but it is still important to avoid generating static charges.
The cup must not be cleaned or rubbed with a dry cloth or paper. It is possible to generate a static charge by rubbing with, if discharged to an earthed object could create an incendive spark and cause solvent vapours to ignite.
Only use a dampened cloth or antistatic wipes if manual cleaning is required within a hazardous area.
- For routine clean/maintenance, do not dismount any other part than air cap, nozzle and needle from the gun (The spray head may need to be cleaned if it is dirty).
If not, the seals & packings inside may face a risk of being out of shape and lead to leakage.

Step-by-step procedure	Important
1. Pour remaining paint out after use. Clean fluid passages and air cap set. Spray a small amount of thinner to clean fluid passages.	1. Incomplete cleaning can fail pattern shape and uniform particles. Especially clean fully and promptly two-component paint after use
2. Clean each section with brush soaked with thinner and wipe out with waste cloth.	2. Do not immerse the whole in thinner for over 1 minute. If done, it may damage parts inside, and lubricating may be needed.
3. Before disassembly, fully clean fluid passages. (1) Disassemble fluid nozzle. Use spanner to remove fluid nozzle. (2) Disassemble fluid needle set. You do not need to remove fluid/needle adj. guide set from gun body. Remove fluid adj. knob and fluid needle spring, and then pull out fluid needle spring, and then pull out fluid needle from back of housing.	3. During disassembly, do not scratch housing section. (1) Remove fluid nozzle after removing fluid needle or while keeping fluid needle pulled, in order to protect housing section. (2) Be careful when handling tip of fluid needle since it is sharp.
4. In order to assemble air valve, first assemble air valve & air valve spring & fluid adj. guide together. Next, insert fluid needle set into fluid adj. guide set, then fit it to gun body set and screw fluid adj. guide set.	4. Service air valve only when it is not functioning correctly (may need cleaning) or significantly air leaks. If you try to fit air valve spring and air valve to gun body without fluid needle set, air valve will not be fitted correctly and lip packing inside fluid adj. guide will be damaged.
5. When you want to adjust fluid needle packing set, first tighten it by hand while fluid needle set remains inserted. Then tighten it further carefully by spanner,	5. Service needle packing only when it is not functioning correctly or significantly air leaks. Too much tightening of fluid needle packing nut can cause bad movement of fluid needle set and fluid leakage from the tip of fluid needle. When you tighten it too much, first fully loosen it and then tighten it again carefully.
6. Turn pattern adj. knob or air adj. knob counterclockwise to fully open, and then tighten pattern adj. set or air adj. set.	6. If pattern adj. knob or air adj. knob is not fully opened, tip of it can contact and damage fluid nozzle and cause seizure of thread.



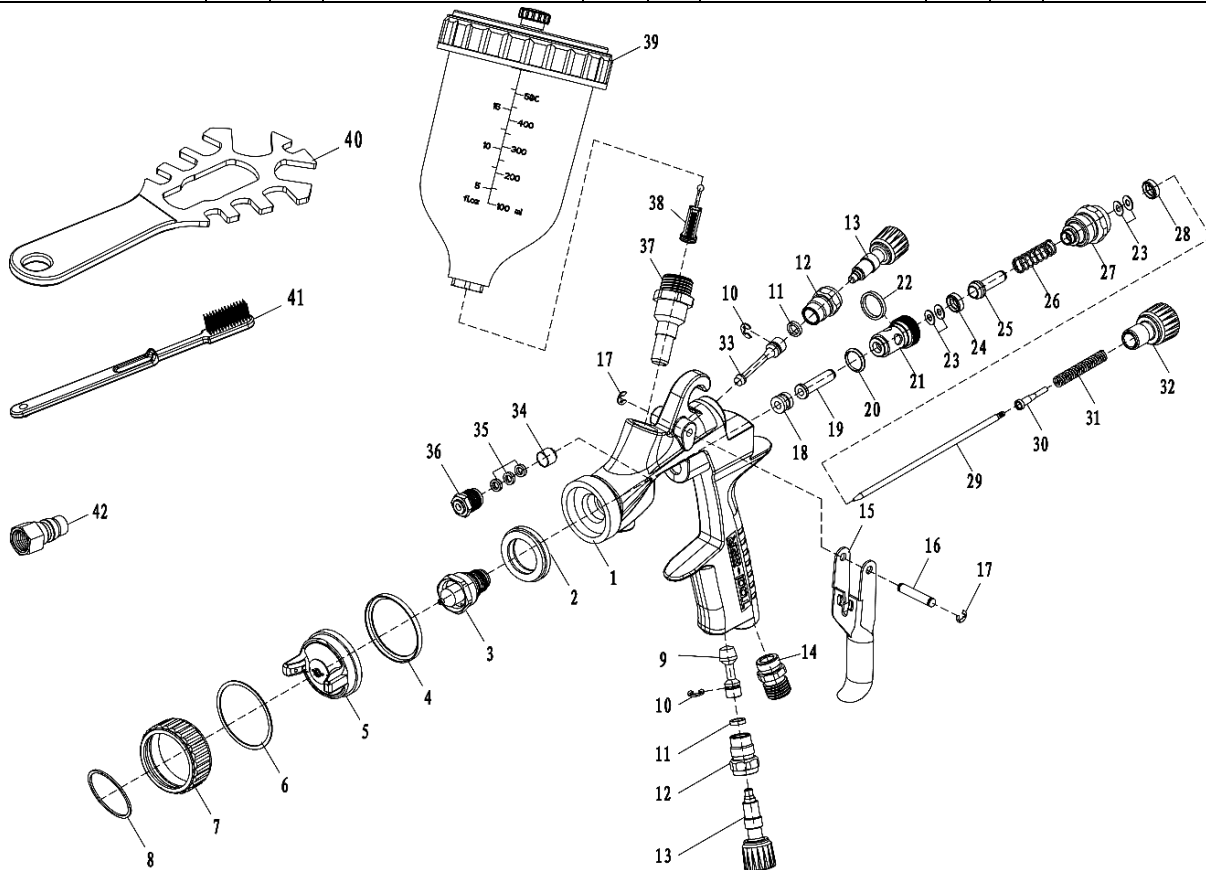

Where to inspect	Parts replacement
1. Each hole passage of air cap and fluid nozzle.	Replace if it is crushed or deformed.
2. Packing and seals	Replace if it is deformed or worn out.
3. Serious leakage between fluid nozzle and needle.	Replace them both if leakage does not stop after fully cleaning fluid nozzle and fluid needle.

Parts list

#	Description	Qty	#	Description	Qty	#	Description	Qty	#	Description	Qty
1	Gun body	1	12	Air/pattern adjusting valve housing	2	23	Air valve shaft seal	2	34	Needle packing	1
2	Air baffle	1	13	Air/pattern adjusting knob	2	24	Air valve shaft seal guide	1	35	Needle packing gasket	1
3	Fluid nozzle	1	14	1/4" air inlet	1	25	Air valve rod	1	36	Packing nut	1
4	Lock ring seal	1	15	Trigger	1	26	Air valve spring	1	37	Fluid inlet	1
5	Air cap	1	16	Trigger pivot	1	27	Needle/fluid adjusting guide	1	38	Filter	1
6	Air cap seal	1	17	Circlip 3	2	28	Washer	1	39	Paint cup	1
7	Lock ring	1	18	Air valve shaft sleeve	1	29	Fluid needle	1	Accessories		
8	Air cap retaining ring	1	19	Air valve shaft	1	30	Needle seat	1			
9	Air adjusting valve rod	1	20	Air valve front seal	1	31	Needle spring	1	40	Spanner	1
10	Circlip 5	2	21	Air valve housing	1	32	Needle/fluid adjusting knob	1	41	Brush A	1
11	Air/pattern adjusting valve seal	2	22	Air valve seal	1	33	Pattern adjusting valve rod	1	42	Plug	1



Troubleshooting

Spray pattern	Problems	Remedies
 Fluttering	1. Air enters among fluid nozzle, air baffle and gun body. It may caused by over-tightened nozzle (>20Nm). 2. Air is drawn from fluid needle packing set. 3. Air enters at fluid inlet or fluid hose joint.	1. Remove fluid nozzle to clean. If it is damaged, replace nozzle.. Do not over-tighten the nozzle. 2. Tighten fluid needle packing screw. 3. Tighten fluid inlet after clean.
 Crescent	Paint buildup on air cap partially clogs horn holes. Air pressure from both horns is different.	Remove obstructions from horn holes with attached brush. But do not use metal objects to clean horn holes.
 Inclined	1. Paint buildup or damage on fluid nozzle circumference and air cap center. 2. Fluid nozzle is not properly fitted.	1. Clean the paint buildup. If it is damaged, replace the damaged part. 2. Remove the nozzle and clean it.
 Split	1. Paint viscosity too low. 2. Fluid output too high.	1. Add paint to increase viscosity. 2. Tighten needle adjust knob to reduce fluid output. Or turn pattern adjust valve set clockwise.
 Heavy Center	1. Paint viscosity is too high. 2. Fluid output too low.	1. Add thinner to reduce viscosity. 2. Turn needle adjust knob counter-clockwise to increase fluid output.

